

INSTRUCTION MANUAL

DIGITAL STORAGE OSCILLOSCOPE

MODEL DSS6520

KIKUSUI ELECTRONICS CORPORATION

82. 9. 20

823984

Power Requirements of this Product

Power requirements of this product have been changed and the relevant sections of the Operation Manual should be revised accordingly.

(Revision should be applied to items indicated by a check mark)

Input voltage

The input voltage of this product is _____ VAC,
and the voltage range is _____ to _____ VAC. Use the product within this range only.

Input fuse

The rating of this product's input fuse is _____ A, _____ VAC, and _____.

WARNING

- To avoid electrical shock, always disconnect the AC power cable or turn off the switch on the switchboard before attempting to check or replace the fuse.
- Use a fuse element having a shape, rating, and characteristics suitable for this product. The use of a fuse with a different rating or one that short circuits the fuse holder may result in fire, electric shock, or irreparable damage.

AC power cable

The product is provided with AC power cables described below. If the cable has no power plug, attach a power plug or crimp-style terminals to the cable in accordance with the wire colors specified in the drawing.

WARNING

- The attachment of a power plug or crimp-style terminals must be carried out by qualified personnel.



TABLE OF CONTENTS

	<u>PAGE</u>
1. GENERAL	1
2. SPECIFICATIONS	2
3. DESCRIPTION OF PANEL ITEMS, USES, AND PRECAUTIONS	8
3.1 Description of Front Panel Items	8
3.2 Description of Rear Panel Items	18
3.3 Examples of Uses and Special Features	21
3.4 Precautions	25
4. OPERATION METHOD	28
4.1 Setting of Switches and Controls	28
4.2 Dual-channel Operation	30
4.3 X-Y Operation (REAL mode)	30
4.4 Sweep Magnification	31
4.5 Sweep Modes	31
4.6 PREDELAY	32
5. D I/O	33
5.1 Memory Access	33
5.2 D I/O Terminal Pins	35
5.3 Description of Signals	36
5.4 Timing of WE Signal	37

823985

1. GENERAL

Model DSS6520 Digital Storage Oscilloscope has both analog oscilloscope functions and storage oscilloscope functions.

When in the analog mode (hereafter, referred to as REAL mode), the oscilloscope operates as a analog oscilloscope with a bandwidth of 20 MHz.

When in the storage mode, the oscilloscope operates with a digital storage function different from the conventional analog storage oscilloscope which employs a storage-type CRT, but the operation method remains basically the same.

The analog input signal is converted into a digital signal by an A/D converter at a speed of 500 nsec and the digital signal is stored in 1024-word digital memory.

The storage display operation is selectable between the auto erase mode and the roll mode. The storage display time is adjustable. A pretrigger function is incorporated to display waveforms before triggering. The set value for this mode of operation denotes the amount written after triggering. This amount is adjustable up to 9.9 DIV.

The stored memory can be protected. An analog signal is provided to prepare a hard copy of the stored signal. A digital signal also is provided for data processing. A function to measure the amplitude and time of span between two points indicated by the cursors also is provided.

The digital storage oscilloscope is capable of capturing, reproducing and analyzing an instantaneous one-shot transient signal. The stored waveform signal can be reproduced on the CRT for any required period of time. When used being connected to a computer, the oscilloscope can be used for various purposes.

823986

2. SPECIFICATIONS

CRT

Type: 6-inch rectangular CRT, with internal graticule

Phosphor: P31

Acceleration voltage: Approx. 2 kV

Effective screen size: 10 DIV \times 8 DIV (10 mm/DIV)

Blanking: DC coupling

Graticule illumination: Continuously variable

Operation modes

- o REAL
- o REAL & STORAGE
- o STORAGE

REAL mode

Vertical axis

Sensitivity: 5 mV - 10 V/DIV, 1-2-5 sequence

MAG \times 5: 1 mV - 2 V/DIV

Sensitivity accuracy: \pm 5% or better (at CAL'D position)

Continuously-variable sensitivity adjustment: Continuously variable covering between two adjoining ranges

Frequency bandwidth: DC: DC - 20 MHz (with reference to 50 kHz)

AC: 2Hz - 20 MHz (within -3 dB)

(MAG \times 5: 10 MHz)

Rise time: Approx. 17.5 nsec
(Approx. 35 nsec when MAG \times 5)

Input impedance: 1 M Ω \pm 2%, 33 pF \pm 2 pF

Input terminals: BNC-type receptacles

Maximum allowable input voltage: 600 V_{p-p} (DC + AC peak; AC component not higher than 1 kHz)
 400 V_{p-p} for 5, 10, 20, 50 mV/DIV ranges and 0.1, 0.2 V/DIV ranges.

Input coupling: AC, GND, DC

Base-line shift caused by range switching: ±0.5 DIV (including DC balance shift)
 ±2 DIV when MAG ×5

Linearity: Vertical amplitude ±0.1 DIV or better when a signal with 4 DIV amplitude at the CRT screen center is moved vertically within the effective screen range.

Vertical-axis operation modes

CH1: Single channel

DUAL: CHOP, 0.5 sec - 1 msec
 ALT, 0.5 msec - 0.2 μsec
 (Linked to TIME/DIV switch)

X-Y: CH1 for X-axis, CH2 for Y-axis

CH2: Single channel

Chop frequency: Approx. 200 kHz

Triggering

Sweep modes: AUTO/NORMAL/SINGLE

Trigger source: INT/LINE/EXT

Internal trigger: CH1/CH2

Sensitivity	DC:	DC - 10 MHz	0.6 DIV
		DC - 20 MHz	1 DIV
	AC:	2 Hz - 10 MHz	0.6 DIV
		2 Hz - 20 MHz	1 DIV

When in AUTO or NORMAL mode

External trigger sensitivity

DC:	DC - 20 MHz	0.5 V
AC:	2 Hz - 20 MHz	0.5 V

Polarity: "+" or "-"

Coupling: AC or DC

EXT trigger

Input impedance: Approx. 1 M Ω

Maximum allowable input voltage: 100 Vp-p (DC + AC peak; AC component not higher than 1 kHz)

Input terminal: BNC-type receptacle

Horizontal axis (time base)

Sweep time ranges: 0.5 sec/DIV - 0.2 μ sec/DIV, 1-2-5 sequence

Continuously-variable adjustment of sweep time: Covering up to 2.5 times or over of the value indicated by TIME/DIV switch

Sweep magnification: 5 times

X-Y mode: CH1 for X-axis input

X-axis frequency bandwidth

DC: DC - 1 MHz (with reference to 50 kHz, 8 DIV)

AC: 2 Hz - 1 MHz (-3 dB)

X-Y phase difference: Within 3 $^\circ$ (at 50 kHz)

STORAGE mode

Vertical axis

Sensitivity: 5 mV - 10 V/DIV, 1-2-5 sequence

A/D converter: 8-bit (256) sequential comparator type

Conversion speed (frequency bandwidth): 500 nsec

Chop frequency for DUAL mode: 200 kHz (for writing)

DC offset: Provided (approximately twice of graticule range)

Others: See the items for REAL mode.

Triggering

See the items for REAL mode. (The signals are supplied from those of the REAL mode. The maximum frequency is 200 kHz.)

Horizontal axis (time base)

Sweep time ranges: 5 sec/DIV - 50 μ sec/DIV

Highest sampling time when in single-channel mode: 500 nsec

Highest sampling time per channel when in DUAL mode: 1 μ sec

Memory capacity: 8 \times 1024

When in single-channel mode: 10 bits 1024 words

When in DUAL mode: 9 bits 512 words

Others: See the items for the REAL mode.

Sweep modes:

AUTO ERASE

ROLL

PREDELAY (ROLL)

TRIG POINT

Amount written after trigger point:

Approx. 0.1 DIV - 9.9 DIV, in 0.1-DIV steps

View time:

Approx. 0.5 sec - 5 sec

(when the knob is pulled out)

Memory protect:

HALF, HALF

When in single-channel mode: Sequentially continuing points are protected alternately, for independent-channel protect or dual-channel protect.

When in DUAL mode: Can be protected independently for each channel.

PEN outputs

Vertical axis: CH1 and CH2, 1 V/DIV, 4 V to -4 V

Horizontal axis: 1 V/DIV, 0 to 10 V

Sync signal: TTL level
Read signal: By TIME/DIV

Z axis

Coupling: DC coupling
Sensitivity: Discernible intensity modulation by
3 Vp-p input
Frequency bandwidth: DC to 5 MHz
Polarity: Darkening by positive input
Input resistance: Approx. 10 k Ω
Input terminal: BNC-type receptacle

Calibration voltage

Waveform: Positive square wave
Output voltage: 1 Vp-p, $\pm 5\%$
Frequency: 1 kHz, $\pm 25\%$
Duty ratio: Within 45:55

Power supply

Line voltage: Selectable
A: 90 - 110 V
B: 104 - 126 V
C: 194 - 236 V
D: 207 - 253 V
Frequency: 50/60 Hz
Power consumption: Approx. 100 VA (with line voltage 100 V)

Dimensions and weight

External dimensions: 310 W \times 150 H \times 400 D mm
(12.2 W \times 5.9 H \times 15.7 D in.)

Maximum dimensions: 370 W × 190 H × 465 D mm
(14.6 W × 7.5 H × 18.3 D in.)

Weight: Approx. 12 kg (26 lbs)

Accessories

P060-S probes, 10:1, 1:1	2
942A terminal adaptors	2
Instruction manual	1

Ambient conditions

Normal operating conditions: 5 to 35°C (41 to 95°F), 80% RH

Operable limit conditions: 0 to 40°C (32 to 104°F), 85% RH

3. OPERATION METHOD

3.1 Description of Front Panel Items (See Figure 3-1.)

- ① POWER: Main power switch of the instrument. When this switch is pressed and locked, the instrument power is turned on and the power pilot lamp turns on.
- ② ILLUM: Graticule illumination control. Graticule becomes brighter as this control is turned clockwise. The graticule is of an internal type.
- ③ INTEN: Spot or trace intensity control. The spot or trace becomes brighter as this control is turned clockwise.
- ④ FOCUS: For focussing the spot or trace to the sharpest image.
- ⑤ TRACE ROTATION: Semi-fixed potentiometer for aligning the horizontal trace with graticule lines. May be used to correct slanting of trace caused by terrestrial magnetism.
- ⑥ CALIB: This terminal provides the calibration voltage of 1 Vp-p, 1-kHz square wave.
1 Vp-p
- ⑦ GND terminal: Ground terminal of the instrument.
- ⑧ Graticule: Internal graticule of CRT. Filter can be easily replaced.
- ⑨ POSITION: Vertical position controls of the spot or trace for CH1. The outer knob is for the REAL mode and the inner knob is for the STORAGE mode. If the outer knob is pulled out when in the STORAGE mode, it operates as a DC OFFSET knob.
- ⑩ CH1 (X): Vertical input terminal of CH1. When in the X-Y mode, X-axis input terminal.

- ⑪ VOLTS/DIV: To select the vertical sensitivity of CH1 (or X-axis), from 5 mV/DIV to 10 V/DIV with 11 ranges. The inner knob is for continuously variable adjustment of sensitivity. The ranges are calibrated with this knob turned to and locked at the CAL'D position. When this knob is pulled out, the input sensitivity is magnified by a factor of 5 and the input sensitivity ranges become 1 mV/DIV to 2 V/DIV. This MAG ×5 function is effective only when in the REAL mode, and the frequency bandwidth in this case is DC to 10 MHz.
- ⑫ AC-GND-DC: Selector switch of input coupling for CH1.
- AC: AC coupling for measurement of AC component.
- GND: Vertical amplifier input is grounded, enabling to check the 0 level on the CRT. The signal input terminal is open.
- DC: DC coupling for measurement of signal including DC component.
- ⑬ POSITION: Vertical position controls of the spot or trace for CH2. The functions are the same as those of CH1.
- ⑭ CH2 (Y): Vertical input terminal of CH2. When in X-Y mode, Y-axis input terminal.
- ⑮ VOLTS/DIV: To select the vertical sensitivity of CH2 (or Y-axis). The functions are the same as those of ⑪.
- ⑯ AC-GND-DC: Selector switch of input coupling of CH2. The functions are the same as those of ⑫.
- ⑰ INT TRIG: Selects the internal trigger source.
- CH1: Input signal of CH1 is used as triggering signal.

- CH2: Input signal of CH2 is used as triggering signal.
- ⑱ VERT MODE: Selects the operation mode of the vertical axis.
- CH1: Single-channel operation with CH1 alone.
- DUAL: Dual-channel operation with both CH1 and CH2 switched in the CHOP mode or ALT mode.
- X-Y: X-Y operation with CH1 as X-axis and CH2 as Y-axis.
- CH2: Single-channel operation with CH2 alone.
- ⑲ SCOPE: The undepressed state is for regular oscilloscope operation.
- PEN: The depressed state is for the PEN mode for hard copying of the data stored to a X-Y recorder in the STORAGE mode.
- The CH1 and CH2 vertical signals, time base (X-axis) signal, and sync signal are delivered via terminals on the rear panel. The output voltages of both X and Y axes are 1 V/DIV. Speed in the X-axis direction is selectable with the time base switch.
- The operation is of a single-sweep set/reset type. The operation starts when the PEN START switch is pressed and it ends when data read is complete. As the START switch is pressed again, the operation point returns to the start point. (This state can be monitored on the CRT screen.)
- ⑳ POSITION: Horizontal position control of the spot or trace. When this knob is pulled out, the sweep is magnified by a factor of 5. The frequency bandwidth becomes slightly narrower when in the MAG ×5 mode.
- PULL MAG ×5:

②① TIME/DIV: Selects the time base for the horizontal sweep, covering 0.5 sec/DIV to 0.2 μ sec/DIV ranges when in the REAL mode and 0.5 sec/DIV to 50 μ sec/DIV when in the STORAGE mode. If this switch is turned to the counterclockwise extreme position when in the STORAGE mode, sampling is made being dictated by an external clock input signal.

When in the dual-channel operation, switching of the two channels is automatically selected between CHOP mode and ALT mode with the 1 msec/DIV and 0.5 msec/DIV ranges as the separating points for the two modes,

CHOP: 0.5 sec/DIV - 1 msec/DIV

ALT: 0.5 msec/DIV - 0.2 μ sec/DIV

The read time when in the STORAGE mode is as follows.

When ②② VAR knob is not pulled out,

CHOP ranges: 2 μ sec clock

ALT ranges: When triggered and writing, at the sampling speed selected by the TIME/DIV switch. Until next triggering after completion, 2- μ sec clock.

When ②② VAR knob is pulled out, the read time as set by the TIME/DIV switch.

②② VAR:
CAL'D

For continuously-variable adjustment of the sweep time when in the REAL mode. The clockwise extreme position (locked position) is the CAL'D position of this knob. The TIME/DIV switch of ②① is calibrated with this knob set in the CAL'D position. If this knob is pulled out when in the STORAGE mode, the read time is selected by the TIME/DIV switch for all ranges.

- ②③ EXT CLOCK: This input terminal accepts a TTL-level external clock signal for writing when in the STORAGE mode. (See (7) of 3.3.)
TTL
- ②④ TRIGGERING: Triggering mode selector buttons
- o AC/DC: Input coupling selector button
 - : AC coupling of triggering signal
 - : DC coupling of triggering signal
 - o +/-: Triggering slope selector button
 - : Triggering is effected as the triggering signal crosses the triggering level in the positive-going direction.
 - : Triggering is effected as the triggering signal crosses the triggering level in the negative-going direction.
 - o INT/LINE/EXT: Triggering source selector buttons
 - INT: An internal signal (CH1 or CH2 signal as selected by ①⑦ INT TRIG switch) is used as the triggering signal.
 - LINE: An AC line frequency signal is used as the triggering signal.
 - EXT: An external signal (applied through the TRIG IN terminal) is used as the triggering signal.
- ②⑤ EXT TRIG: An external triggering signal is applied through this terminal. When ②④ TRIGGERING selector is set in the EXT state, triggering is effected by the signal applied through this terminal.
- ②⑥ LEVEL: To adjust the write starting point (level) of the input signal. The triggering level becomes higher as the outer knob is turned clockwise, and vice versa. If the inner knob is pulled out when in the STORAGE mode,
- 
 FULL VIEW TIME

the display time is adjustable for a range of approximately 0.5 to 5 seconds. The waveform is displayed on the CRT screen until this period is over and the next trigger is applied. If this knob is pulled out when in the SINGLE mode, the trace disappears as the read operation stops. The trace appears when the instrument has become the stored state.

②⑦ SWEEP MODE:

Sweep mode selector buttons

AUTO:

Sweep runs automatically even when no adequate triggering signal is applied.

NORMAL:

Sweep runs when adequate triggering signal is applied. If no adequate triggering signal is applied, sweep is in the ready state and no trace is displayed.

SINGLE:

Sweep runs only once when it is triggered. To start the next sweep, the sweep circuit must be reset once to the ready state.

Operation for the STORAGE mode is as follows: When the sweep is triggered and the write operation is done, ②⑨ STORED lamp turns on and the written waveform is maintained until the circuit is reset.

This button is used also as a timing reset button when in the STORAGE mode. When an abnormal state is caused, this button may be pressed to reset the circuit.

②⑧ READY:

This lamp turns on when the sweep is ready.

②⑨ TRIG'D:

This lamp turns on when the sweep is triggered.

③⑩ STORED:

This lamp turns on when the circuit is triggered and the write operation has been completed, in the STORAGE mode.

③1 DISPLAY MODE: Display mode selector buttons

REAL: The instrument operates as a regular oscilloscope.

REAL & STORAGE: The instrument operates both as a regular oscilloscope and as a storage oscilloscope. (The signal of the same channel is displayed in both regular and storage modes. When the VERT MODE switch is set for the DUAL mode, the CH1 signal is displayed.)

AUTO ERASE: In this STORAGE mode, each time a trigger pulse is applied, the trace on the CRT is refreshed by a newly stored waveform. The display time on the CRT is adjustable with the VIEW TIME knob. If the SWEEP MODE switch is set in the NORMAL or SINGLE state, the trace remains on the CRT screen until the next trigger is applied.

ROLL: The waveform displayed by the preceding trigger is rewritten by that displayed by the current trigger, in a roll-out manner.

Point being currently rewritten

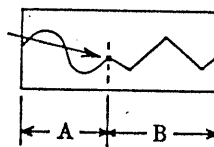

A: Waveform displayed by current trigger

B: Waveform displayed by preceding trigger

PREDELAY: The predelay function is used to store and display the waveform which existed before triggering, in the ROLL mode. The amount of delay can be set up to 9.9 DIV. The set amount means the amount of stored signal after triggering. The screen is calibrated from the right-hand end of the trace line.

The trace line exceeds the graticule by 2.4%. To align the trace line with the graticule line, move the trace line with the HOR POSITION control.

The triggering point is displayed with a marker dot on the waveform.

The amount of delay can be set with CURSOR 1 switch in (32), for observation of waveforms both before and after triggering.

(32) MEASUREMENT:

The measured value is displayed with LEDs -- with 4 digits (2 digits when in DIV mode) and with a sign (minus). Each time the FUNCTION switch is pressed, display mode is switched to the triggering point PREDELAY mode, voltage measurement mode, and time measurement mode. When in the PREDELAY mode, the red DIV lamp turns on; when in the voltage measurement mode, the red V or mV lamp turns on; when in the time measurement mode, the green S, mS, or μ S lamp turns on.

PREDELAY:

The PREDELAY time can be set for a period of up to 9.9 DIV in 0.1-DIV steps with cursor 1. The right hand position of the switch is for counting up and the left hand position is for counting down. Counting is in a ring count system, that is, when 9.9 is exceeded in up-counting, the value returns to 0, or when 0 is exceeded in down-counting, the value returns to 9.9. Each time the switch is thrown, the value advances by 0.1 step. If it is held thrown for more than 0.5 sec., the value automatically advances by 100 msec.

UP: 0 0.1 0.2 0.3 ... 9.7 9.8 9.9 0 0.1
DOWN: 9.9 9.8 9.7 ... 0.3 0.2 0.1 0 9.9
9.8

Voltage Measurement and Time Measurement

Voltage or time (period) between two points indicated by cursors (dots) 1 and 2 on the displayed waveform can be measured. Cursor 1 is used as the reference point and the voltage or time of cursor 2 is measured and displayed. (Voltage measurement is relative voltage measurement.)

The value displayed is as calculated using range information at the instant of triggering (storing) and the LED lamp corresponding to the unit of measure automatically turn on.

When in the DUAL mode, the measured voltage of either channel can be selected with the TRIG selector switch.

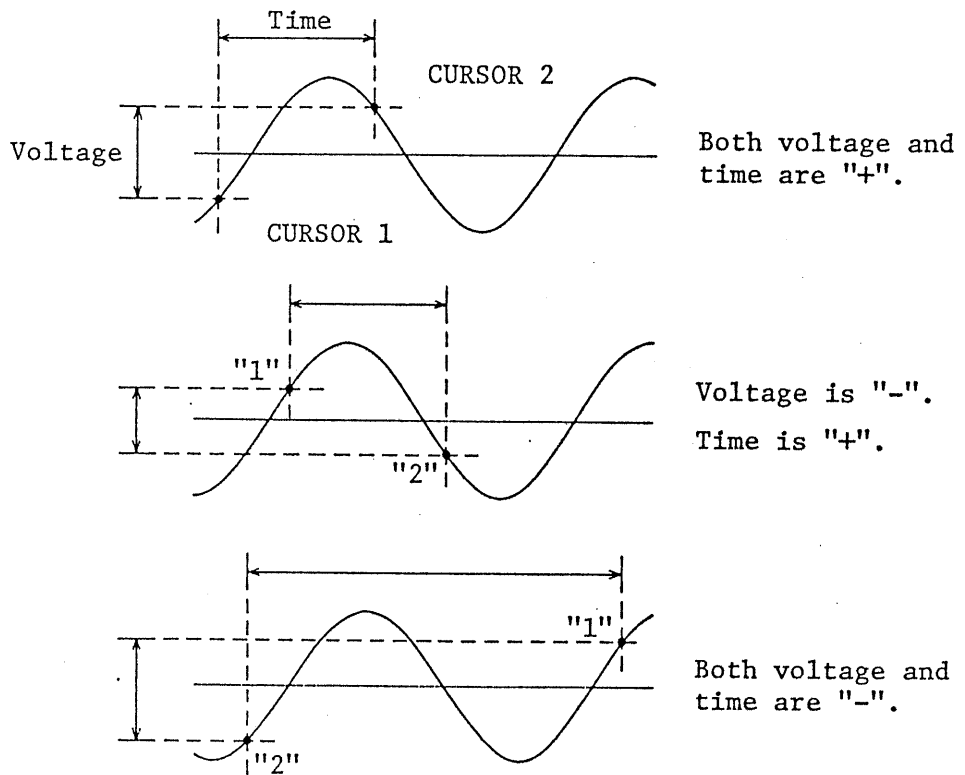

Cursors 1 and 2 move rightward as their switches are thrown rightward, and vice versa. Each time the switch is thrown once, its cursor moves by one step. If it is held trown for more than 0.5 sec., its cursor is automatically updated at every 10 msec.

- o When a continuous input signal is applied and measured, its displayed value may vary and mesurement may be inconvenient. In such a case, store the signal once in memory and then display the value of the stored signal so that measure-ment can made more conveniently.

③③ MEMORY PROTECT:

Memory protect selector buttons.

When in the single-channel mode, HALF/HALF protect can be made and the continuously sequential points can be protected alternately and independently, or for all points.

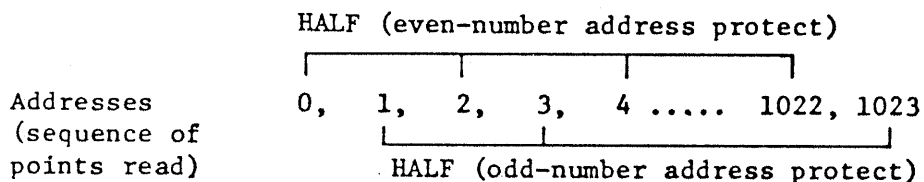

When in the dual-channel mode, both channels are protected mutually independently.

Note: Memory is volatile. It is not protected when the instrument power is turned off.

③④ Graticule:

When in the STORAGE mode, the graticule is as follows.

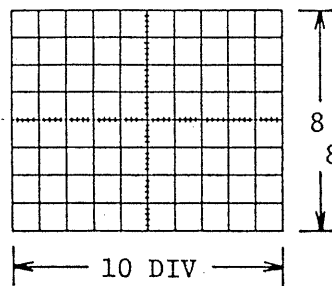

1 DIV/10 mm, internal graticule

8 DIV
8 bits (256)

The bits for the vertical scale are assigned with approximately 5% overscale for each of top and bottom, and those for the horizontal scale with approximately 2.4% overscale.

Single-channel:
10 bits (1024 words)

Dual-channel:
9 bits (512 words)

3.2 Description of Rear Panel Items (See Figure 3-2.)

- ③⑤ CH1 SIGNAL OUTPUT: Output terminal of CH1 signal (when in the REAL mode). Can be used for connecting a frequency counter to this terminal for a frequency measurement.
- ③⑥ Z AXIS INPUT: Input terminal for external intensity modulation signal. May be used to externally control the trace intensity and to apply a marker signal.
- ③⑦ PEN OUT: Output terminals of the stored signals in the analog form. The signals are constantly delivered.
- CH1: Output terminal of CH1 analog signal.
- CH2: Output terminal of CH2 analog signal.
- TIME BASE: Output terminal of X-axis analog signal as selected by the TIME BASE switch.
- SYNC/TTL LEVEL: Output terminal of a signal synchronized with the sweep signal. Used for such purpose as set/lift control of recorder pen.

824003

- ③⑧ FUSE: AC power line fuse holder
- ③⑨ Line power: Input connector of the AC line power
- ④⑩ LINE VOLTAGE SET: AC line voltage selector. Set the arrowhead mark at the corresponding AC line voltage position.
- A: 90 - 110 V
- B: 104 - 126 V
- C: 194 - 236 V
- D: 207 - 253 V
- ④⑪ DI/O: Digital input/output terminal. (Kikusui GP-IB Interface IF01-DSS can be connected to this terminal.)

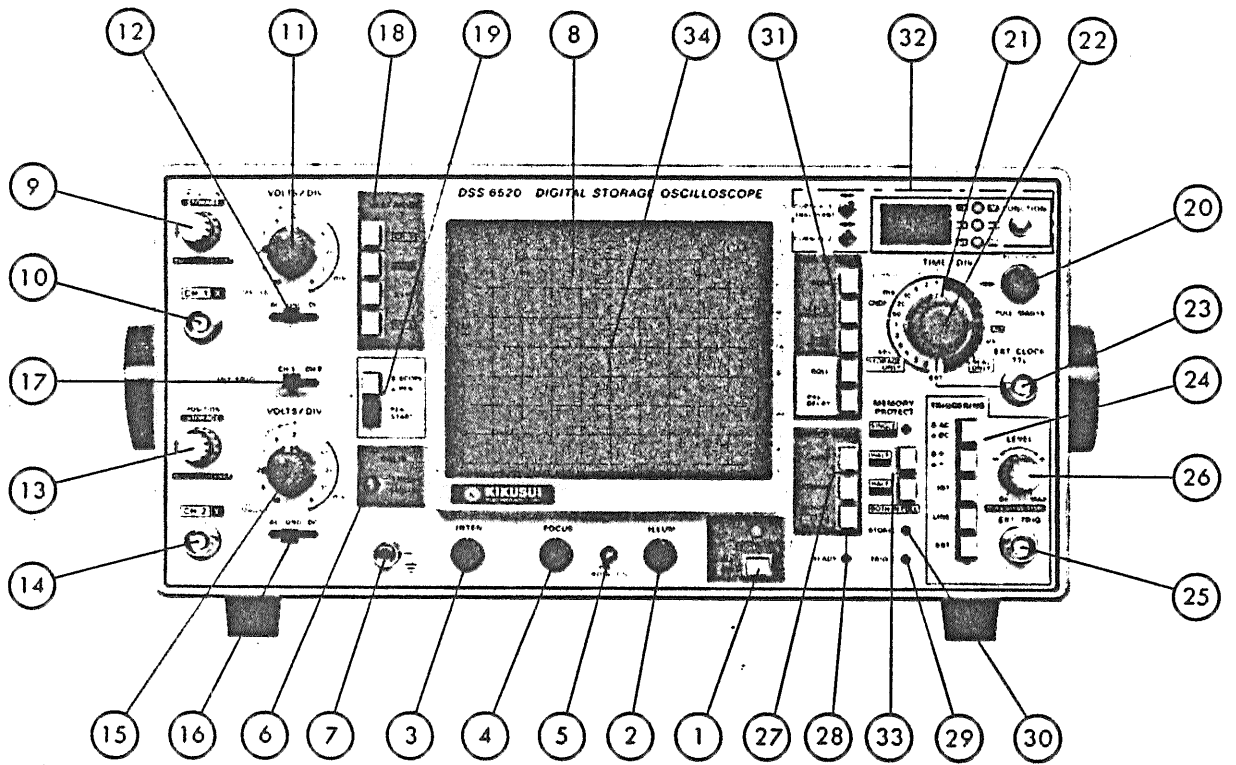

Figure 3-1

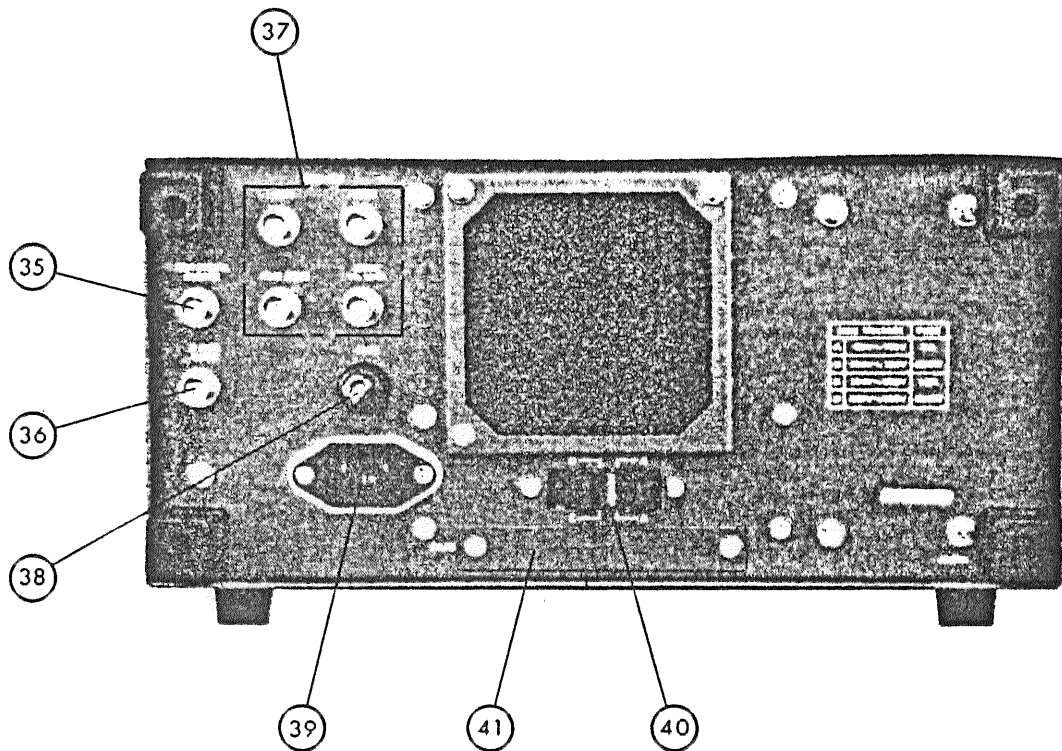
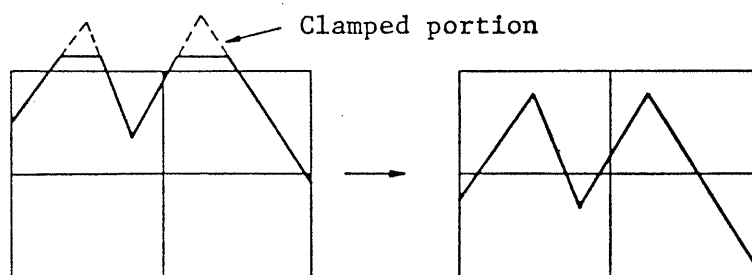

Figure 3-2

3.3 Examples of Uses and Special Features

(1) DC Offset

When an AC signal which is superimposed on a DC component is applied to the input terminal, the AC component which is to be displayed and measured may be saturated and clamped. In such a case, the DC offset function may be used to cancel out the DC component.



The DC offset function is effected when the outer VERT POSITION knob is pulled out. When the DC offset function is effected, the POSITION control remains idle.

(2) PEN

The PEN function is used to obtain a hardcopy of the stored waveform. For this function, the X-Y signals and sync signal are available at the output terminals on the rear panel.

The PEN operation starts as you change the operation mode from the SCOPE mode to the PEN mode and press the PEN START switch. The operation proceeds at the sampling speed selected by the TIME BASE switch and stops when the final data has been read. (When the operation mode is changed from the SCOPE mode to the PEN mode, the read time is set as selected by the TIME BASE switch.)

As you press the START button again, the operation returns to the starting point.

The waveform is monitored on the CRT screen at the same time.

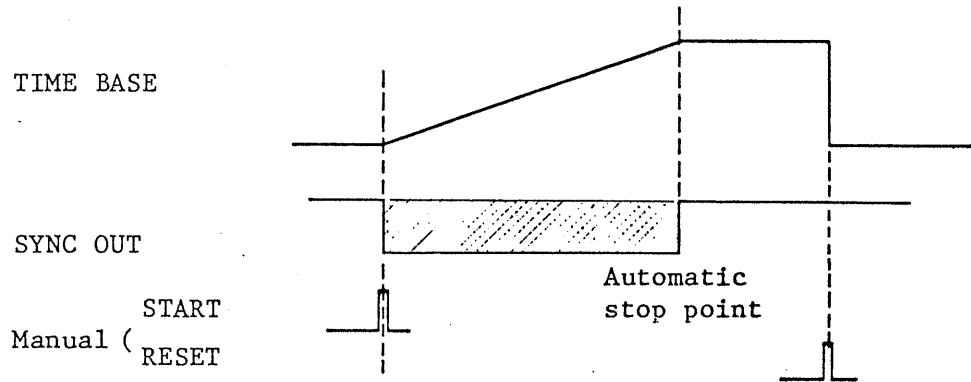

(3) Recording of one-shot signal

The signal of a one-shot event can be recorded using the SINGLE mode. When the circuit is triggered and the write operation is over, the instrument enters the STORED state and displays the stored waveform until it is reset.

A phenomenon which occurs only once at an unpredictable time can hardly be measured with the regular oscilloscope mode. Such phenomenon can be effectively measured with the single-sweep operation of a storage mode, which automatically captures the phenomenon as it occurs and automatically stores the waveform. When used in conjunction with the PREDELAY function, this SINGLE mode provides a very efficient means of measurement for the waveform both before and after the triggering.

(4) Setting of view time when the input signal is continuously triggered

When the input signal is continuously triggered in the AUTO or NORMAL sweep mode, the displayed waveform is automatically refreshed for each trigger pulse unless the memory protect function is in effect. When this automatic refreshing is undesirable and a certain view time is needed, it can be obtained and adjustable for a period of 0.5 to 5 seconds with the VIEW TIME knob.

824007

(5) Comparison with a reference signal

(5)-1. REAL & STORAGE modes

In the STORAGE mode, keeping the trigger mode constant, store the reference signal and protect it with the FULL MEMORY PROTECT feature. Next, change to the R&S mode so that the REAL signal can be compared with the protected reference signal.

(5)-2. STORAGE mode

Operating the instrument in the DUAL mode, write the reference signal in CH1 or CH2, protect the corresponding channel, and apply a measured signal to the other channel.

Or, operating the instrument in the single-channel mode, write the reference signal and protect it with the HALF MEMORY PROTECT, and then compare the measured signal with the reference signal.

- | | | | |
|---------------------|------------------------|--------------------------|-----------------------------------|
| 1. Reference signal | 2. HALF PROTECT signal | 3. Two signals identical | 4. Difference between two signals |
|---------------------|------------------------|--------------------------|-----------------------------------|



The four waveforms indicate the difference between the two signals, the frequency of the measured signal is lower. When the frequency of the measured signal is raised to that of the reference signal, the displayed waveforms will conform as shown in 4.

Phase and amplitude also can be measured in a similar manner.

824008

- (6) To measure a waveform which existed before triggering

Different from the regular oscilloscope, the Digital Storage Oscilloscope is capable of measuring the waveform which existed before triggering, although triggering of the Digital Storage Oscilloscope depends on the slope and level of the triggering signal as in the case of the regular oscilloscope. It often happens that the state which existed before triggering is needed to be known, especially in the cases of one-shot phenomena. The waveform which existed before triggering can be measured by employing the PREDELAY function in the SINGLE mode.

- (7) Use of external clock signal

The oscilloscope can be operated with its sampling speed dictated by an external clock signal (TTL level). This feature is very convenient for maintaining synchronization with an external circuit, as one conversion is made per one clock pulse. The maximum input frequency is 2 MHz at the SINGLE mode, and 1 MHz at the DUAL mode. This mode is used in the ROLL mode, with the TIME BASE CAL'D knob pulled out.

3.4 Precautions

(1) AC line voltage:

Before operating the instrument, be sure to check that the LINE VOLTAGE selector on the rear panel is set at the correct position for the AC line voltage on which the instrument is to be operated. If the LINE VOLTAGE sector is not correctly set, the instrument may be damaged or may not operate properly.

(2) Environments:

Do not operate or store the instrument in high temperature, high humidity environments for a long time as such will cause damage of the instrument or shortening of the instruments life. Do not operate the instrument in a strong magnetic or electric field.

(3) CRT intensity:

Do not make the trace intensity excessively high. Do not leave the spot stationary for a long time. Such will shorten the CRT life.

Time base:

Time base setting ranges differ between the REAL mode and the STORAGE mode. If operated in an incorrect range, no sweeps may run or erroneous operation may result.

REAL: 0.5 sec/DIV - 0.2 μ sec/DIV

STORAGE: 5 sec/DIV - 50 μ sec/DIV

(4) Memory protect:

Memory is volatile. It is not backed up by any battery. Stored data is lost when the AC line power is turned off.

(5) Display error when in STORAGE mode:

The Digital Storage Oscilloscope displays waveforms in sampling periods. Note that perceptual aliasing may result if a signal of which frequency is higher than the set time base is applied.

(6) Allowable maximum voltages of input terminals:

The allowable maximum voltages of the input terminals and probes are as shown in the following. Do not apply input voltages higher than these limits as such will cause damage to the instrument.

CH1, CH2 terminals 5, 10, 20, 50 mV/DIV 0.1, 0.2 V/DIV	400 V (DC + AC peak)
Probe (960 BNC)	600 V (DC + AC peak)
EXT TRIG terminal	
EXT CLOCK terminal	TTL level
Z AXIS INPUT terminal	

(7) Fan motor filter:

The fan motor is of a suction type. Clean the filter at appropriate intervals.

(8) Uniformity of intensity:

1. When in the AUTO ERASE mode and especially in the CHOP ranges, the right-hand part of the CRT screen may become darker depending on the input signal frequency. This is not an abnormal indication. If such darkening is inconvenient for viewing, turn on the VIEW TIME function, use the ROLL mode, or pull out the TIME BASE vernier switch.
2. When in the ROLL mode, the trace starting point at the right-hand part on the CRT screen may become brighter. This is not an abnormal indication.
3. In the cases of 1 and 2, or a combination of these cases, ununiformity of trace intensity may result. It results from the operating principles of the instrument and it is not an abnormal indication.

- (9) Pretrigger operation in storage mode:
- o When the triggering point is set at 0 DIV, the pretriggering function is not effected and the READY lamp does not turn on.
 - o Note that the stored and indicated value may not be reliable (errors may be introduced) when the 50 μ S/DIV range is used in the pretriggering mode in the DUAL channel operation.
- (10) To write out the data stored in the memory using a pen-writing recorder or other similar instrument, switch the oscilloscope from the SCOPE mode to the PEN mode after making it sure that the STORED lamp is on. If the oscilloscope is switched to the PEN mode and back into the SCOPE mode when the oscilloscope is in a sweep operation, the sweep operation may stop. This is caused as the oscilloscope is switched to other mode while it is in operation. When this has happened, press the RESET (SINGLE) button once so that the oscilloscope is reset and the normal sweep resumes.
- (11) When an input signal of continuous waveform is displayed on the CRT screen using an external clock signal, abnormal pulses may be superimposed on the displayed waveform and the overall waveform may become suggestive of dropped bits. This is caused by asynchronization between the external clock signal and the internal read clock signal. This has no adverse effects on the data being stored. If the above display state is inconvenient from the viewpoint of waveform observation, the oscilloscope may be operated in the READ TIME NORMAL mode (the state that the TIME/DIV VAR switch is pulled out). When operated in this mode, the displayed waveform becomes normal, although the storage operation at the low frequency range may be slightly degraded. Even if the internal read clock signal is used, the above abnormal display state disappears when the oscilloscope is operated in the STORED mode.

824012A

4. OPERATION METHOD

4.1 Setting of Switches and Controls

Before connecting the AC power cord to an AC line outlet, set the switches and controls as follows:

(Item numbers are as shown in Figure 2-1.)

Item No.	Switch or control	Setting
1	POWER	<input type="checkbox"/> OFF
9, 13	POSITION	Inner knob (REAL knob): Mid-position Outer knob (STORAGE knob): Mid-position; not pulled out
11, 15	VOLTS/DIV	10 V/DIV range
12, 16	Input coupling selector	GND (center position)
18	VERT MODE	CH1 (Depress the button.)
17	INT TRIG	CH1
19	SCOPE/PEN	SCOPE <input type="checkbox"/>
3	INTEN	Mid-position or more clockwise position
4	FOCUS	Mid-position
2	ILLUM	Counterclockwise extreme position
31	DISPLAY MODE	REAL or AUTO ERASE (Depress the button.)
21	TIME/DIV	0.5 mS
22	VAR	CAL'D position; not pulled out
20	POSITION	Mid-position
27	SWEEP MODE	AUTO button depressed <input type="checkbox"/>
33	MEMORY PROTECT	Undepressed state <input type="checkbox"/> <input type="checkbox"/>

Item No.	Switch or control	Setting
24	TRIGGERING	AC <input type="checkbox"/> + <input type="checkbox"/> INT <input checked="" type="checkbox"/> (depressed state)
26	LEVEL	Inner knob: Mid-position Outer knob: Mid-position; undepressed state

After setting the switches and controls as above, connect the power cord to an AC line outlet of the correct voltage.

- (1) Press the POWER switch. The lamp will turn on to indicate that the instrument power is on.
- (2) A trace will appear on the CRT in approximately 10 seconds. Adjust the trace brightness to an appropriate intensity with the INTEN knob.
- (3) Adjust the trace to the sharpest image with the FOCUS knob.
- (4) Connect the probe cable to the CH1 input terminal and the probe tip to the CALIB terminal. (Use the 1:10 probe.)
- (5) Set the input coupling selector switch to the DC position and the VOLTS/DIV switch to the 50 mV range. Adjust the LEVEL (trigger) knob so that the displayed waveform becomes stationary. Check the phase compensation of the probe and adjust it as required.

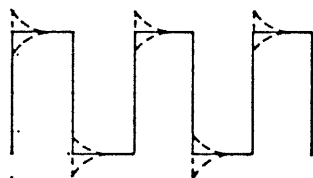

If the displayed waveform is as indicated with the dotted lines, adjust it to the waveform as indicated with the solid lines by adjusting the phase compensation control of the probe.

- (6) Set the VOLTS/DIV, TIME/DIV, TRIGGER MODE, and other selector switches in conformity with the amplitude, frequency, and other characteristics of the signal to be measured.

The above explanation is for the case of single-channel operation with CH1. Ch2 may be used in a similar manner; dual-channel operation also may be used as required.

4.2 Dual-channel Operation

Depress and lock the DUAL button of the VERT MODE selector so that both CH1 and CH2 traces are displayed. The two traces are swept in the CHOP mode or in the ALT mode, as either one of these modes is automatically selected being linked to the TIME/DIV switch.

CHOP	REAL:	0.5 sec/DIV - 1 msec/DIV
	STORAGE:	5 sec/DIV - 1 msec/DIV
ALT	REAL:	0.2 msec/DIV - 0.2 μ sec/DIV
	STORAGE:	0.2 msec/DIV - 50 μ sec/DIV

Either CH1 or CH2 signal can be used as the internal triggering source signal. The trace positions are adjustable with respective POSITION knobs.

4.3 X-Y Operation (REAL mode)

Depress the X-Y button of the VERT MODE selector so that the instrument operates as an X-Y scope with CH1 for the X axis and CH2 for the Y axis. Of the Y axis, the electrical performances and operation method remain the same with that of CH2. Of the X axis, the frequency bandwidth becomes DC - 1 MHz (-3-dB), the CH1 POSITION control remains idle, and the horizontal POSITION control directly operates as the X-axis POSITION control. (When in the STORAGE mode of X-Y operation, the SINGLE switch is used for the STORED signal. When in the R/S mode, the instrument operates in the CHOP range. When operation is switched to the ALT range, the instrument displays waveforms either in the REAL or STORAGE mode.)

4.4 Sweep Magnification

Pull out the horizontal POSITION knob so that part of the sweep is magnified by 5 times to right and left, with the center of the screen as the center of magnification. The part to be magnified is adjustable by turning the horizontal POSITION knob. The waveform stored in the STORAGE mode also can be magnified as well as the waveform being swept in the REAL mode.

4.5 Sweep Modes

(1) AUTO mode:

Stable triggering operation can be made with a triggering signal of 50 Hz or over. Even when no triggering signal is applied, the sweep runs in a free mode and the zero level is indicated. Bright traces are displayed even at high sweep ranges. This sweep mode is most commonly used for general waveform measurement.

(2) NORMAL mode:

Triggering is effected and sweeps run only when a triggering signal of an effective amplitude and level is applied to drive the trigger circuit.

If no effective trigger signal is applied when in the REAL mode, the trace is in the standby state and not displayed on the CRT. If no effective triggering signal is applied when in the STORAGE mode, the waveform which was stored in the previous triggering cycle is displayed on the CRT.

(3) SINGLE mode:

The SINGLE mode is used to measure a non-repetitive signal or a one-shot signal. When in the REAL mode, the trace is swept only once and then disappears. When in the STORAGE mode, the trace remains on the CRT until the circuit is reset and the next trigger is applied.

4.6 PREDELAY

Depress and lock the ROLL and PREDELAY buttons of the DISPLAY MODE selector and set the triggering point. Setting of the triggering point is to set the amount of write after triggering. The amount is indicated in terms of graticule divisions and it can be set up to 9.9 DIV in 0.1-DIV steps. The triggering point is indicated with a cursor on the waveform. Setting of the triggering point is made with reference to the right-hand end of the trace line. Since the trace line is overscaled by 2.4%, the trace position should be adjusted to the scale line by means of the horizontal POSITION knob.

Assume that waveforms before and after the triggering point are to be displayed fifty-fifty (50% and 50%). For this display, set the triggering point at 5.0 DIV. Set the triggering level and then press the SINGLE buttons of the SWEEP MODE selector. The waveform is written and displayed until the triggering point. After the triggering point, the waveform for 5 DIV is written and displayed.

For rewriting, press the SINGLE button each time.

5. D I/O

5.1 Memory Access (The D I/O is only for Kikusui GP-IB Interface.)

The D I/O is used to deliver the stored data as a digital signal and to accept an external digital signal into the oscilloscope.

(1) Normal storage-scope operation

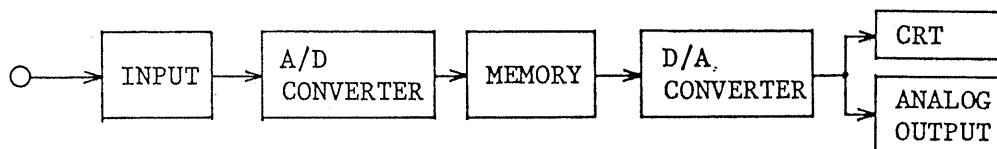

(2) To deliver data stored in the storage oscilloscope: By applying an external address signal, an output for the corresponding data stored in the oscilloscope is delivered and at the same time the data is displayed on CRT.

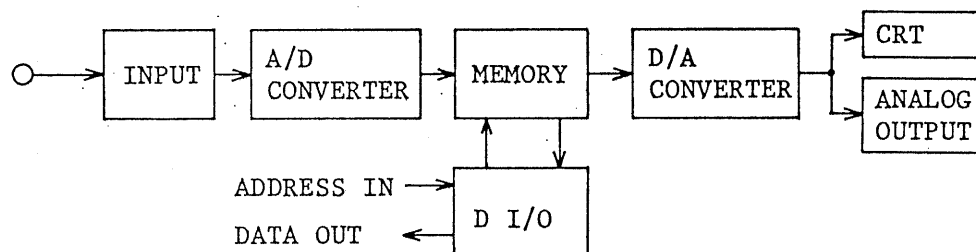

(3) To specify the memory addresses with an external signal, to write data at such addresses, and to monitor the written data with CRT.

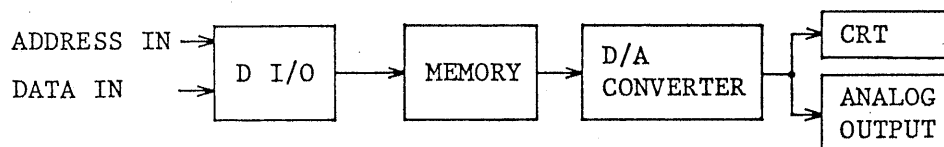

(4) Entry of external reference signal for comparison: In the case of dual channels, provide channel memory protect; in the case of comparison with REAL waveform in the R/S mode, provide BOTH protect.

824018

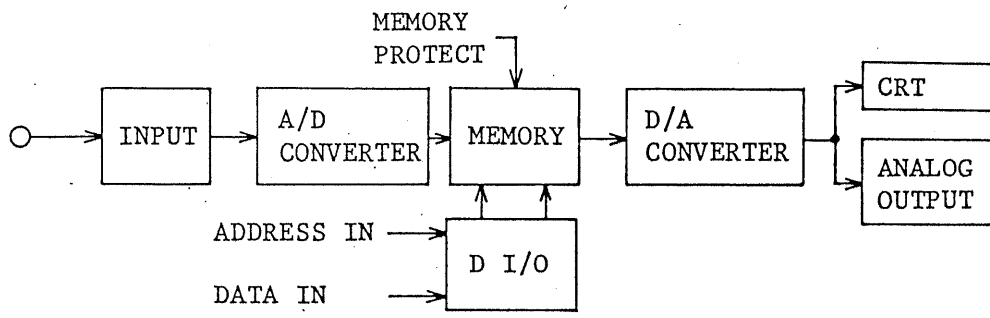

824019

5.2 D I/O Terminal Pins

GND	1	2	D0
"	3	4	D1
"	5	6	D2
"	7	8	D3
"	9	10	D4
"	11	12	D5
"	13	14	D6
"	15	16	D7
"	17	18	
"	19	20	
"	21	22	
"	23	24	
A0	25	26	A1
A2	27	28	A3
A4	29	30	A5
A6	31	32	A7
A8	33	34	A9
	35	36	
GND	37	38	STORED
"	39	40	WE
"	41	42	DI
"	43	44	SINGLE
"	45	46	BUSY
"	47	48	REMOTE
"	49	50	WRITE END

5.3 Description of Signals

REMOTE: L level, No. 48 (IN)

When the REMOTE mode is specified by the signal applied through the D I/O terminal, read/write operation of memory is controlled by external signals and the panel switches for storage oscilloscope mode remain idle.

SINGLE: L level, No. 44 (IN)

For the single-sweep mode. When the circuit is triggered and data is stored, the operation is reset as the SINGLE state is released once.

L → H → L

This function is used in such case that a waveform is to be stored once and sent out as a digital output signal.

Input → Store → Output

DI: L level, No. 42 (IN)

This input/output switching signal for data is used when directly reading/writing the memory in the REMOTE mode.

WE:  Pulse signal, No. 40 (IN)

This write-enable signal is used to write data in memory in the REMOTE mode.

WRITE END:  Pulse signal, No. 50 (IN)

As this signal is applied when the write operation in the REMOTE mode is over, the circuit becomes the STORED state and the indicator lamp turns on.

824021

STORED: L level, No. 33 (OUT)

When the write operation is over in the LOCAL mode, the STORED lamp turns on and this signal is delivered. (SINGLE sweep)

BUSY: L level, No. 46 (OUT)

This signal is delivered during the period the circuit is triggered and is in the write operation.

5.4 Timing of WE Signal

